

# Salamander Pumps



## AquaScan



## User Guide



This document should be retained for future reference. Should you need to contact Salamander Pumps you will need the below information:



# Contents

---

|  |           |
|--|-----------|
| <b>Safety and contact information</b>                      | <b>4</b>  |
| <b>Intended use</b>  | <b>6</b>  |
| <b>Box contents</b>  |           |
| a) AquaScan carrycase                                      | <b>7</b>  |
| b) Contents  | <b>8</b>  |
| <b>Product overview</b>                                    |           |
| a) Product description                                     | <b>10</b> |
| b) AquaScan overview                                       | <b>10</b> |
| c) Control buttons   | <b>11</b> |
| d) AquaScan display  | <b>12</b> |
| e) Readings  | <b>13</b> |
| <b>Operation</b>   |           |
| a) First use   | <b>15</b> |
| b) Charging  | <b>15</b> |
| c) Turning on / turning off                                | <b>18</b> |
| d) Reset peak values                                       | <b>19</b> |
| e) Change display  | <b>21</b> |
| <b>Common connection examples</b>                          |           |
| a) Garden tap – direct connection                          | <b>22</b> |
| b) Garden tap – hose adaptor connection                    | <b>22</b> |
| c) Garden tap - hose adaptor connection with flexible hose | <b>23</b> |
| d) 15mm pipe connection                                    | <b>23</b> |
| e) 22mm pipe connection                                    | <b>24</b> |
| f) Kitchen tap - aerator connection                        | <b>24</b> |
| g) Kitchen tap - mixer connection                          | <b>25</b> |
| h) Single tap connection                                   | <b>25</b> |
| i) Shower hose connection                                  | <b>26</b> |
| j) Shower arm connection                                   | <b>26</b> |
| k) Washing machine connection                              | <b>27</b> |
| l) AquaScan isolation valve removed                        | <b>27</b> |
| m) AquaScan isolation valve connected to hose              | <b>27</b> |

---

---

|   |           |
|---|-----------|
| <b>Carrying out a measurement</b>                                     |           |
| a) Guidance:  | <b>28</b> |
| b) Measuring flow rate (L/min)  | <b>28</b> |
| i) Flow rate at one outlet  |           |
| ii) Total incoming flow rate.   | <b>29</b> |
| c) Measuring pressure (Bar)   | <b>30</b> |
| i) Static pressure  |           |
| ii) Dynamic pressure (Bar)  |           |
| d) Measuring temperature (°C)   | <b>31</b> |
| e) Measuring hardness via TDS reading (PPM)                           | <b>31</b> |
| <b>Improving water performance after measurements have been taken</b> | <b>34</b> |
| a) Increasing flow in mains-fed systems                               | <b>34</b> |
| b) Increasing pressure in mains-fed systems                           | <b>36</b> |
| c) Increasing pressure in gravity-fed systems                         | <b>38</b> |
| <b>Treating hard water</b>  | <b>41</b> |
| <b>Service and maintenance</b>  | <b>42</b> |
| a) Maintenance  |           |
| b) Cleaning   |           |
| c) Storage  |           |
| <b>Technical data</b>   | <b>43</b> |
| <b>Troubleshooting</b>  | <b>44</b> |
| <b>Warranty</b>   | <b>49</b> |
| <b>Terms and conditions</b>   | <b>50</b> |

---

# Safety and contact information

## a) Observe prior to use

- Please read this instruction manual carefully and familiarise yourself with the product before putting it to use.
- Please retain this user guide for future reference to usage, maintenance, and safety information.
- Pay particular attention to the safety information in order to prevent injury and damage to the product.
- AquaScan provides an indication of water pressure, temperature, flow and total dissolved solids (TDS)/hardness.

## b) General safety instructions

- Only operate the product for its intended purpose, and within the parameters specified in the technical data. Incorrect usage could cause serious injury, death, property damage and invalidate the warranty.
- Do not operate the product if there are signs of damage.
- Although the product is IPX5 rated, do not submerge in water.
- Do not attempt to perform maintenance or repairs on the product. Please contact Salamander Pumps.
- Limit operation to the specific measurement ranges specified in the technical data.
- These products are not intended for use by persons (including children) with reduced physical, sensory, or mental capabilities, or lack of experience and knowledge, unless they have been given supervision or instruction concerning use of the product in a safe way by a person responsible for their safety and understand the hazards involved.
- Children should be supervised to ensure that they do not play with the product.
- Cleaning and user maintenance shall not be made by children without supervision.
- Do not drop the product or subject it to sudden impacts.
- AquaScan is suitable for use indoors and outdoors, provided adequate protection from excessive temperatures and humidity is in place.
- If the product is used in a manner not specified by the manufacturer, the protection provided by the product may be impaired.
- Do not leave the product in direct sunlight.

## c) Battery

- The internal battery is part of the integral design, any attempt to change or modify the battery will invalidate the warranty.
- This product contains batteries that can only be replaced by the manufacturer.

## d) Disposal

- At the end of its useful life, please dispose of the product at the collection point for electric and electronic devices (observe local regulations).
- Dispose of batteries in accordance with the valid legal specifications.

## e) Contact

To register your product, view, print or download the latest manual, and for product selection support go to [www.salamanderpumps.co.uk](http://www.salamanderpumps.co.uk)

Salamander Pumps  
Unit 2c Colima Avenue  
Enterprise Park West  
Sunderland  
SR5 3XE

Tel: 0191 516 2002  
Email: [Tech@salamanderpumps.co.uk](mailto:Tech@salamanderpumps.co.uk)

## Register your warranty

Online at: [www.salamanderpumps.co.uk](http://www.salamanderpumps.co.uk)

By phone: 0191 516 2002



## Intended use

AquaScan is a digital water multimeter, it will measure water pressure, flow, temperature, and will give an indication of water hardness via Total Dissolved Solids (TDS).

It may only be used under the conditions and for the purpose for which it was designed. The readings provided by the unit are an indication only.

The product is designed for the following tasks/areas:

- Measurement of water pressure, flow, temperature, and total dissolved solids (TDS) to give an indication of water hardness..
- General plumbing diagnostics.
- This product is only for use with clean water.













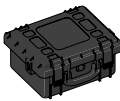

The product should not be used in the following areas:







- For diagnostic measurements in the medical field.
- Permanent installation to a plumbing system.
- For any purpose where other types of liquid need to be measured.
- For any purpose where a greater degree of accuracy is required.

## AquaScan carrycase



# Box contents

|   |   |   |
|---|---|---|
|  |  |  |
| AquaScan unit x1  | AquaScan isolation valve x1   | Carry case x1   |
|  |  |  |
| User guide x1   | AquaScan results notepad x1   | MainsBooster range brochure x1  |
|  |  |  |
| GravityBooster range brochure x1  | USB-C to USB cable 1m x1  | Salamander Pumps pen x1   |
|  |  |  |
| 3/4" male thread to hose quick connector x1                                       | 3/4" female thread to hose quick connector x1                                     | 15mm pipe push fit to 3/4" male thread x1   |
|  |  |  |
| 22mm pipe push fit to 3/4" male thread x1   | Mixer tap hose connector x1   | Single tap to male hose connector x1  |

|  |   |   |
|--|---|---|
|  |  |  |
| 3/4" thread to 1/2" thread adaptor x1  | 1/2" male to male 1/2" connector x1   | 3/4" washers x2<br>1/2" washers x2  |
|  |  |  |
| Hose with 3/4" male and 3/4" female connection (300mm length) x1                   | 3/4" male thread to male hose connector x1  | 3/4" female thread to male hose connector x1  |
|   |   |   |
| Male and female aerator thread to male hose connector x1                           |   |   |

Please note AquaScan fits most outlet types, however there will be instances where other fittings are needed.

**Buy replacement connections**

Online at: [www.salamanderpumps.co.uk](http://www.salamanderpumps.co.uk)



# Product overview

## a) Product description

AquaScan is a digital water multimeter. It combines the technology to measure pressure, flow, temperature, and total dissolved solids (TDS)/hardness in one unit.

Readings are shown on the digital display including peak and live measurements.

The user can reset the peak readings using the reset button and select between alternative displays using the display button.

AquaScan is supplied in a robust storage case with a range of accessories for easy connection to common outlet types.

The unit is powered by an integral battery, rechargeable via a USB-C input.

## b) AquaScan overview

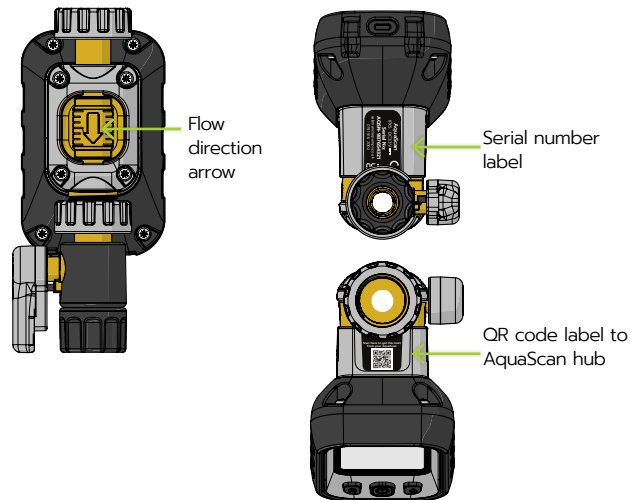
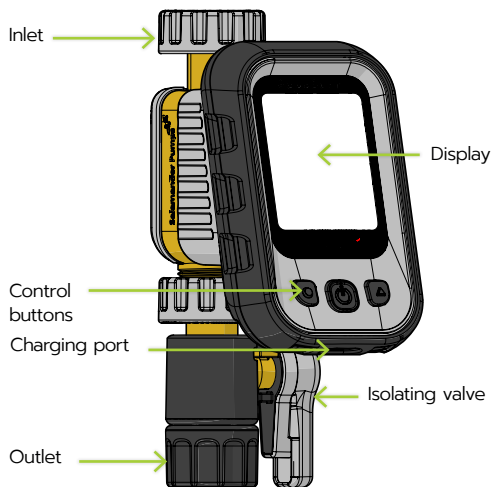

## c) Control buttons

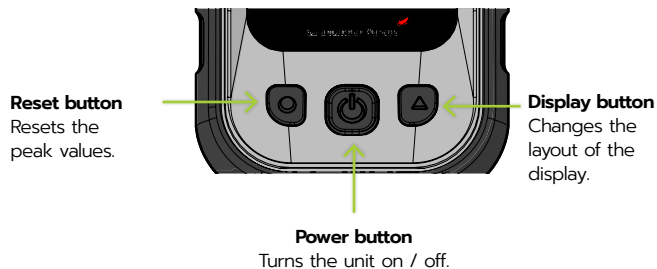

#### d) AquaScan display

Display 1 - animated

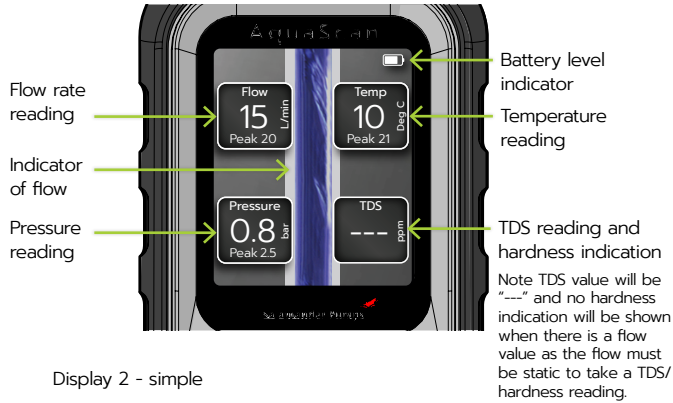

Display 2 - simple



Display 3 - QR code



#### e) Readings

Display 1 - animated - flow reading

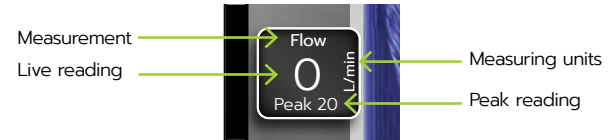

Display 1 - animated - TDS reading and hardness indication

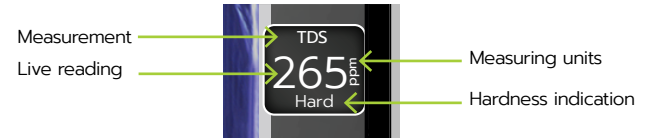

Display 2 - simple - flow reading

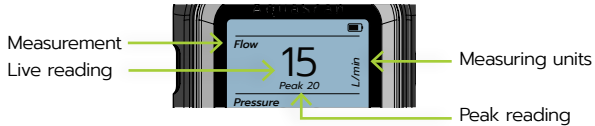

Display 2 - simple - TDS reading and hardness indication

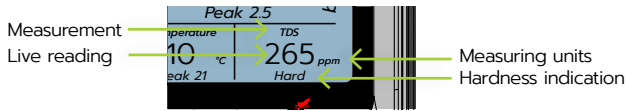

(Note - TDS value will be "---" and no hardness indication will be shown when there is a flow value as the flow must be static to take a TDS reading).

## Operation

### a) First use

Before first use AquaScan must be fully charged.

### b) Charging the battery

To charge AquaScan follow the steps below:

1. Always use the USB-C to USB cable supplied with AquaScan.
2. Plug the USB-C into USB-C port on AquaScan.

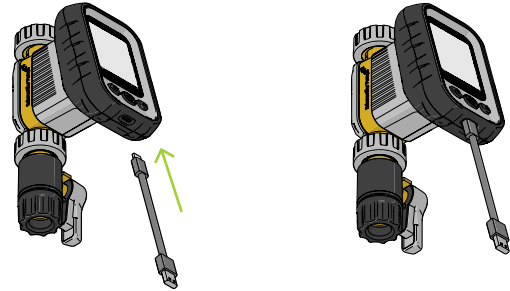

3. Plug USB into a compatible 5V power supply.

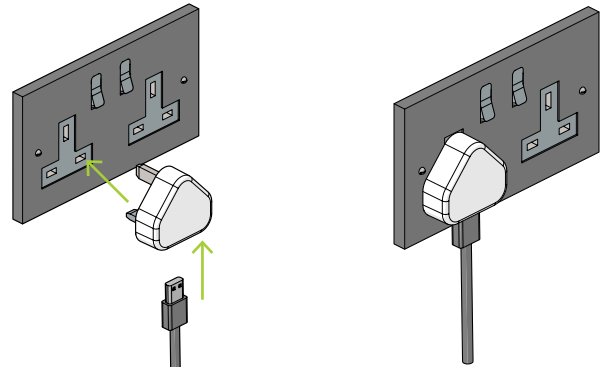



4. When AquaScan is turned on, the battery level indicator will change to 'charging':

*Display 1 - animated*



*Display 2 - simple*



*Display 3 - QR code*



When AquaScan is turned off and charging the display below will be shown.



Battery level indicator will animate to indicate charging:



### c) Turning on / turning off:

1. Press and hold power button for 2 seconds to turn on.

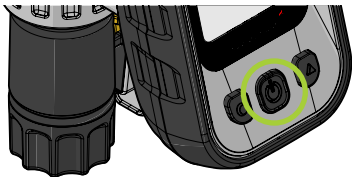

2. AquaScan will turn on.

*Power on  
display 1 - animated*



*Power on -  
display 2 - simple*



*Power on -  
display 3 - QR code*



3. Press and hold power button for 2 seconds to turn off.  
AquaScan will turn off.

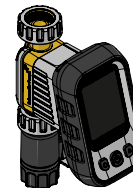
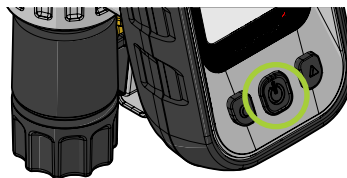

Please note:

- AquaScan will power up with the last used display.
- AquaScan will automatically power off after 20 minutes to save battery power.

### d) Reset peak values:

1. The peak values are shown for each reading.



2. Press reset button to reset peak values.

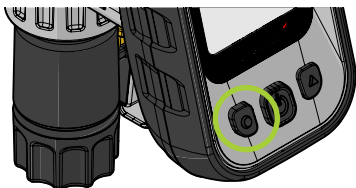

3. The peak values will reset to the current values.

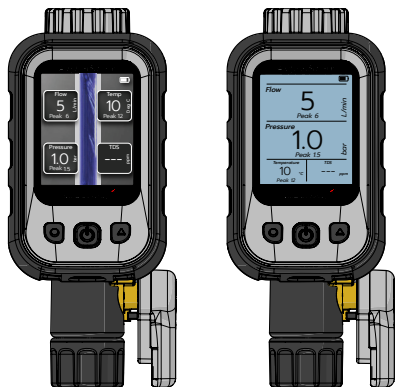

### e) Change display

1. AquaScan has three available displays:

Display 1 - animated



Display 2 - simple



Display 3 - QR code



2. Press display button to change display

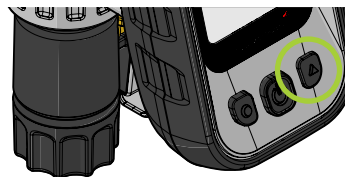

Please note AquaScan will power up with the last used display.

# Common connection examples

AquaScan comes with a variety of connection accessories to allow the unit to be connected to various outlets.

Some common examples are:

## a) Garden tap – direct connection

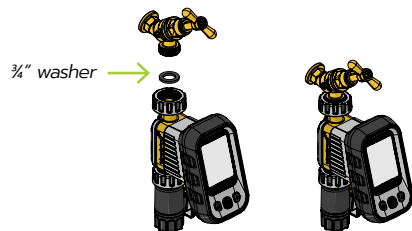

## b) Garden tap – hose adaptor connection

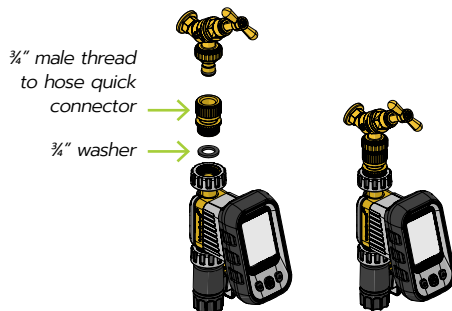

## c) Garden tap - hose adaptor connection with flexible hose

The hose supplied with AquaScan can be used to direct water to a convenient waste point. Do not allow the hose to bend/kink as this will restrict the flow and prevent an accurate reading.

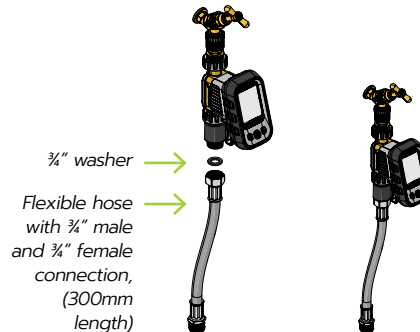

## d) 15mm pipe connection

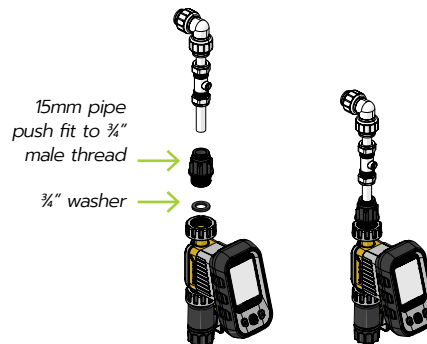

### e) 22mm pipe connection

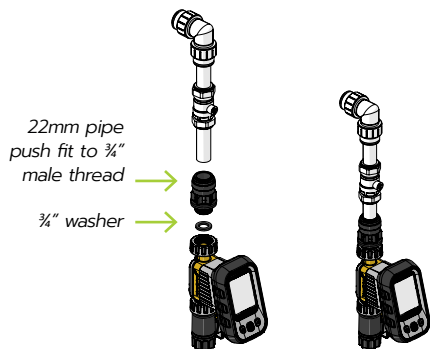

### g) Kitchen tap - mixer connection

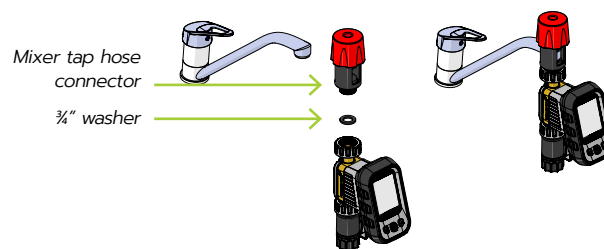

### f) Kitchen tap - aerator connection

Remove the aerator from the tap first, before connecting AquaScan.

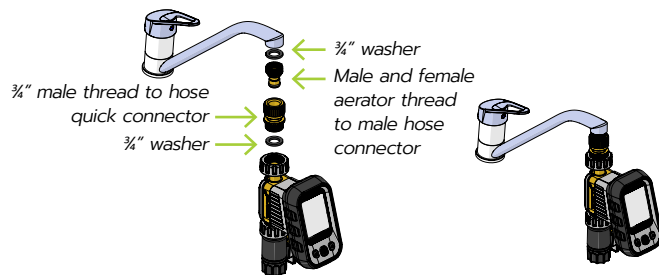

### h) Single tap connection

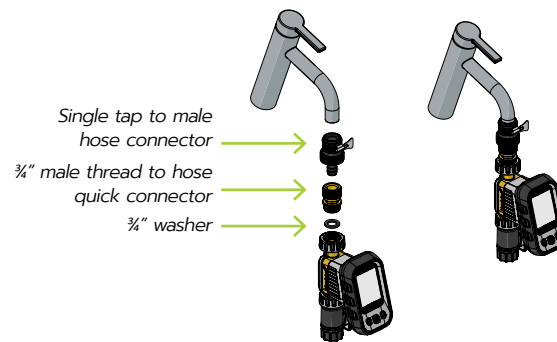

i) Shower hose connection\*

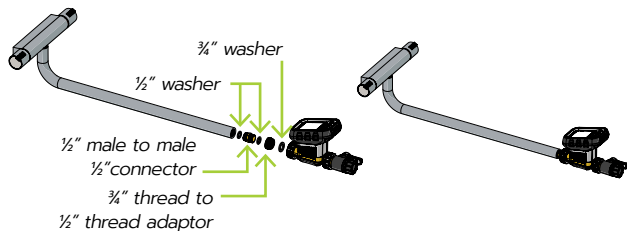

j) Shower arm connection\*

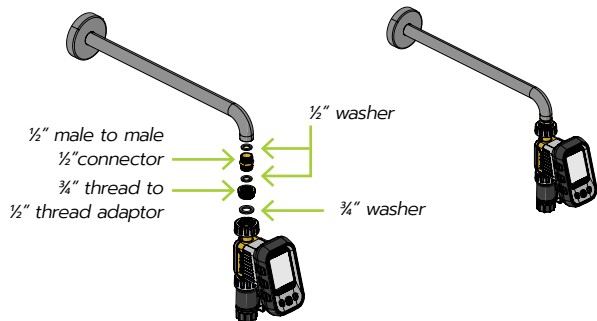

\* This method should not be followed when measuring the water flow rate when specifying a gravity fed pump. Please visit the Salamander Pumps website for more information.

k) Washing machine connection

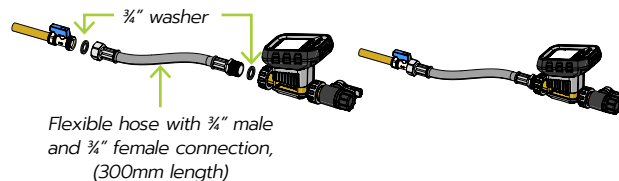

l) AquaScan isolation valve removed

The supplied isolating valve can be removed by unscrewing to allow AquaScan to fit into tight spaces.



m) AquaScan isolation valve connected to hose

The supplied isolating valve can be connected to the flexible hose to allow AquaScan to fit into tight spaces. Do not allow the hose to bend/kink as this will restrict the flow and prevent an accurate reading.

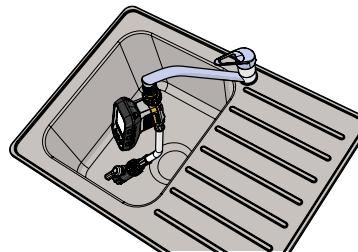

# Carrying out a measurement

## a) Guidance:

- For improved accuracy take three readings and calculate an average. Between each reading press the reset button to reset the peak values.
- Do not use tools to tighten AquaScan connections, they only need to be hand tight.
- When the isolation valve on the outlet of the product is open, water will flow out of the outlet. Position the outlet over a suitable container for the flow to discharge into such as a basin or bucket.
- Some outlets are restrictive by their nature, this will limit the water delivered from the outlet, please check with the manufacturer of the outlet to determine if this the case.
- Pipework can be restrictive, this can limit the water delivered via the pipework.
- The information provided by AquaScan is based on the time and location of use.
- The hose supplied with AquaScan can be used to enable use in a confined space.

## b) Measuring flow (L/min)

### 1. Flow rate at a specific outlet

- 1) Connect AquaScan to the outlet (guidance on this is outlined in section Common connection examples).
- 2) Ensure the isolation valve on AquaScan is fully open.
- 3) Fully open the outlet.
- 4) Allow 30 - 60 seconds for the flow rate to settle.
- 5) Take the measurement from the live 'Flow reading'
- 6) Record the measurement in the AquaScan results notepad.

Flow - display 1 - animated



Flow - display 2 - simple



AquaScan can measure up to 30L/min. If the flow rate at one outlet exceeds 30L/min or if you believe the AquaScan is restricting the flow follow the steps to measure the total incoming flow.

## 2. Total incoming flow rate.

A garden tap is the best location to measure the incoming flow rate, as they are commonly the closest outlet to the incoming mains supply and are often unrestricted.

When this isn't possible, such as in properties where there is no outside tap, measuring the flow rate while multiple outlets are open is the best way to calculate the total incoming flow rate, as this ensures any restrictive outlets do not impact the measurement.

- 1) Connect AquaScan to the first outlet (guidance on this is outlined in section Common connection examples).
- 2) Ensure the isolation valve on AquaScan is fully open.
- 3) Fully open the outlet. Use cold water only to measure total incoming flow rate.
- 4) Allow 30 - 60 seconds for the flow rate to settle.
- 5) Take the measurement from the live 'Flow' reading.
- 6) Record the measurement in the AquaScan results notepad in the 'Outlet 1 - Flow' box.
- 7) Open another outlet (so both are turned on).
- 8) Check the flow rate on AquaScan:
  - a) If the flow rate remains the same, then continue to open further outlets until it decreases.
  - b) If the flow rate decreases, use AquaScan to measure the flow rate at each outlet (all outlets must remain turned on), make a note of the flow rate in the specification notepad. Add the flow rates together to determine the total flow rate, then record this in the total flow rate section of the AquaScan results notepad.

Example:

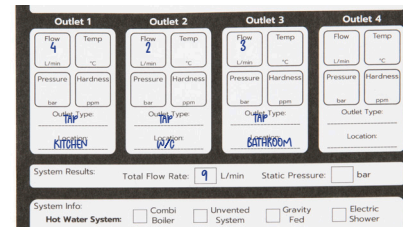

### c) Measuring pressure (Bar)

#### 1. Static pressure

Measure static pressure at an outlet on the ground floor (or on the same level as the where the mains enters the property). Ensure all outlets in the property are closed during test.

- 1) Connect AquaScan to the outlet to be tested (guidance on this is outlined in section Common connection examples).
- 2) Ensure the isolation valve on AquaScan is fully open.
- 3) Fully open the outlet.
- 4) Close the isolation valve on AquaScan.
- 5) Allow 30 - 60 seconds for the water pressure to settle.
- 6) Take the measurement from the 'Pressure' reading.
- 7) Record the measurement in the AquaScan results notepad in the 'Outlet 1 - Pressure' box.

*Pressure - display 1 - animated*



*Pressure - display 2 - simple*

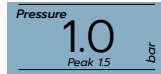

- 8) Open the isolation valve to allow water to flow and then turn off the outlet.

Note: The pressure should always read "0.0" before removing the unit from the outlet.

#### 2. Dynamic pressure (Bar)

- 1) Connect AquaScan to the outlet to be tested (guidance on this is outlined in section Common connection examples).
- 2) Ensure the isolation valve on AquaScan is fully open.
- 3) Fully open the outlet.
- 4) Allow 30 - 60 seconds for the water pressure to settle.
- 5) Take the measurement from the 'Pressure' reading.
- 6) Record the measurement in the AquaScan results notepad in the 'Outlet 1 - Pressure' box.
- 7) Turn off the outlet.

Note: The pressure should always read "0.0" before removing the unit from the outlet.

### d) Measuring temperature (°C)

Warning: It is vital that precautions are taken when measuring the temperature of hot water to prevent serious injury.

- 1) Connect AquaScan to the outlet (guidance on this is outlined in section Common connection examples).
- 2) Ensure the isolation valve on AquaScan is fully open.
- 3) Fully open the outlet.
- 4) Allow 30 - 60 seconds for the water temperature to settle.
- 5) Take the measurement from the live 'temperature' reading.
- 6) Record the measurement in the AquaScan results notepad in the 'Outlet 1 - temperature' box.



*Temp - display 1 - animated*

*Temp - display 2 - simple*

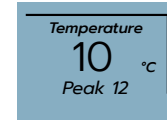

- 7) Turn off the outlet.

### e) Measuring hardness via TDS reading (PPM)

- 1) Connect AquaScan to the outlet (guidance on this is outlined in section Common connection examples).
- 2) Ensure the isolation valve on AquaScan is fully open.
- 3) Fully open the outlet. Use cold water only to measure TDS.
- 4) Allow 30 - 60 seconds for the water to settle.
- 5) Allow the water to flow through AquaScan, then fully close the isolation valve. This will trap some water inside the unit.
- 6) The TDS reading will only show when there is no flow passing through AquaScan.
- 7) If no TDS reading is shown, open and close the valve a few times to ensure there is no trapped air inside.
- 8) Take the measurement from the live 'TDS' reading. The hardness indication will be shown below the TDS reading.
- 9) Record the measurement in the AquaScan results notepad in the 'Outlet 1 - Hardness' box.



TDS/Hardness  
- display 1 - animated



TDS/Hardness  
- display 2 - simple

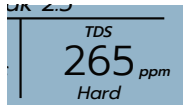

- Open the isolation valve to allow water to flow and then turn off the outlet.

Note: It is advised to allow a settling time of 30-60 seconds once the isolation valve has been closed for a more accurate reading.

If a water softener is fitted, the TDS reading/hardness indication should be taken before the water softener as they can affect the accuracy of the readings, as the minerals added by the softener will artificially increase the TDS reading and hardness indication.

The higher the reading the more likely limescale will build up on pipes and appliances in the home. Limescale build up restricts flow and increases the amount of energy required to heat water in appliances such as kettles, boilers, washing machines and dishwashers.

## HARDNESS



Source: Drinking Water Inspectorate "Hardness of Water". Available from: <https://www.dwi.gov.uk/consumers/learn-more-about-your-water/water-hardness-hard-water/>

To control temperature  
a TMV can be installed

Find out more: [www.salamanderpumps.co.uk](http://www.salamanderpumps.co.uk)



# Improving water performance after measurements have been taken

## a) Increasing flow in mains-fed systems

Many homes suffer with low water flow. This can be caused by a number of factors, including inadequate mains water supply, restrictive pipework, collapsed mains water pipe, and restrictive outlets.

There are many solutions available that will increase the water flow in a property. The example below illustrates how the Salamander Pumps MainsBooster range can provide a boost to water flow rates. View the full range on the Salamander Pumps website.

Example: A property currently has a total incoming water flow rate of 20L/min and an unvented cylinder but cannot run all showers at the same time without the flow dropping off.

The vertical red line on the graph indicates 20L/min. Salamander Pumps' TankBoost, AccuBoost 450L or AccuBoost 330L will deliver more than 20L/min, with TankBoost delivering up to 80L/min. Increasing the flow rate will allow multiple outlets to be used at the same time.

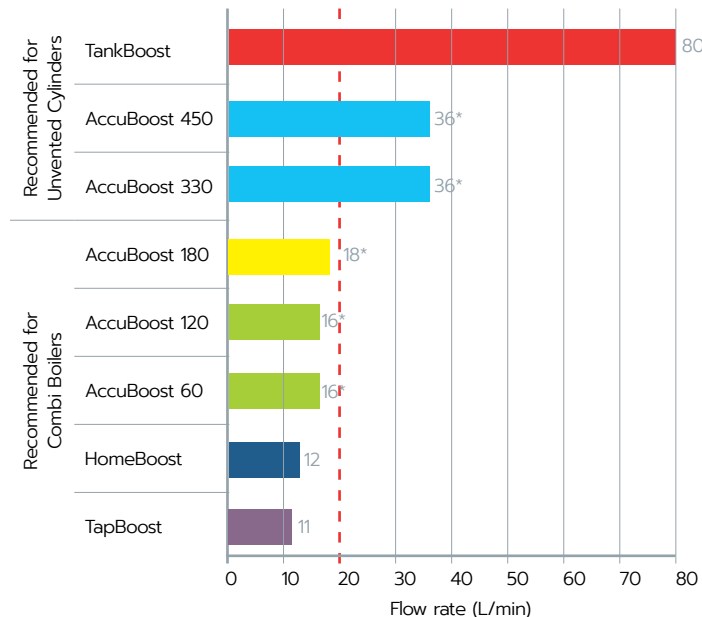

\*Assumes a natural mains flow rate of 12L/min in addition to the flow provided by the accumulator.

### Visit the AquaScan hub

For further information and guidance for finding the right product for the property.



## b) Increasing pressure in mains-fed systems

Many homes in the UK suffer with low water pressure, our range of products can offer a solution to overcome this. The graph below shows the pressure TapBoost, HomeBoost and TankBoost can deliver.

Example: A property currently has 1.0 Bar pressure at 20L/min but the water isn't reaching the outlets on the top floor, so the taps are trickling and the shower doesn't work at all.

The red line on the graph shows at 20L/min flow rate, Salamander Pumps' TankBoost will deliver 2.7 Bar pressure. Therefore by installing TankBoost the pressure is strong enough to boost the water to the outlets on the top floor..

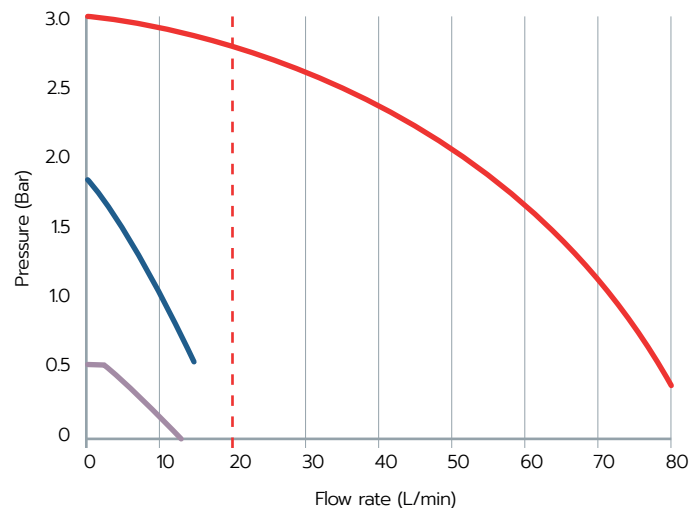

TapBoost HomeBoost TankBoost

## Visit the AquaScan hub

For further information and guidance for finding the right product for the property.



### c) Increasing pressure in gravity-fed systems

Gravity fed systems are still widely used in homes across the UK, they rely on gravity to push water around the system, which often isn't forceful enough for powerful showers or flowing taps.

The pumps in Salamander Pumps' range will improve the pressure in these systems, whether you need to boost water pressure for a single shower or tap, multiple outlets in the bathroom, or throughout the entire house.

15 Bar Pumps

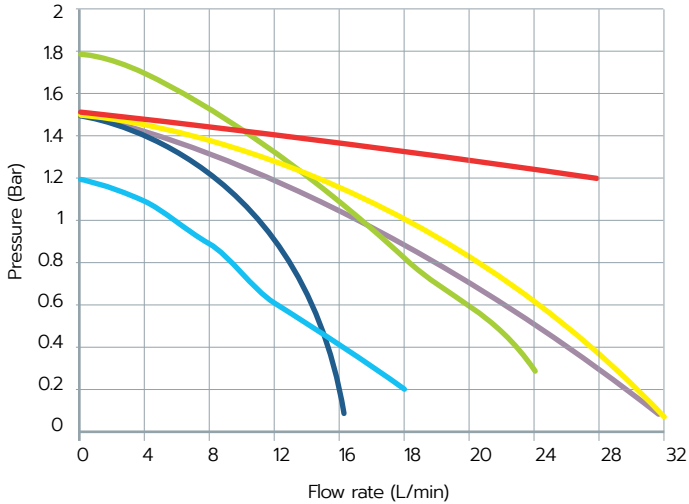

- CT50 XTRA      CT55 XTRA      CT60B/BU
- CT Force 15PT/TU      RP55SU      RP50PT/TU

20 Bar Pumps

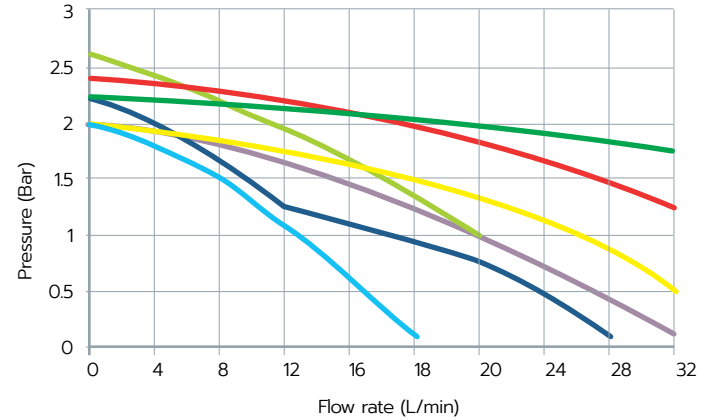

- CT75 XTRA      CT85 XTRA      CT80B/BU
- CTFORCE 20PT/TU      CTFORCE 20PS/SU      RP80SU
- RP75TU

## Treating hard water

Hard water (high limescale content) can be treated with products such as Salamander Pumps' range of water conditioners.

### a) Which water conditioner do I need?

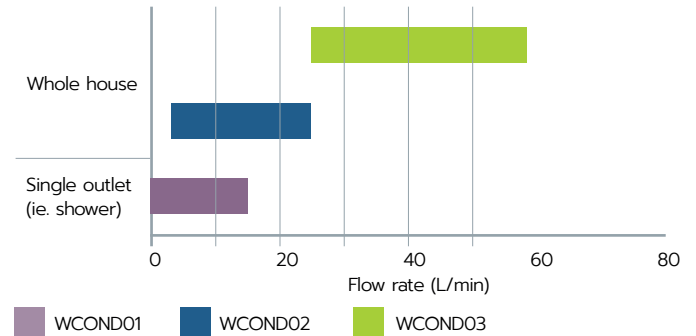

Example:

TDS reading and water hardness indication: 220PPM - Hard  
Flow rate: 20L/min

Recommended product: WCOND02

### 3.0 Bar Pumps

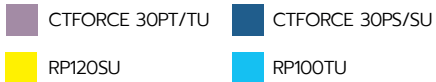
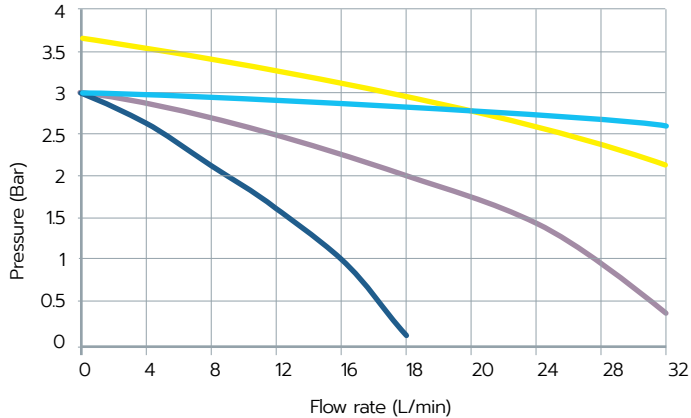

## Visit the AquaScan hub

For further information and guidance for finding the right product for the property.



# Service and maintenance

## a) Maintenance

When operated in accordance with the user guide, AquaScan does not require any particular maintenance. In the unlikely event a malfunction occurs, contact Salamander Pumps.

## b) Cleaning

- Before cleaning, the unit must be switched off and disconnected from any outlets also remove the USB cable.
- Wipe with a damp cloth.
- Never use any harsh cleaning agents or solvents. After being cleaned, the product must not be used until it has completely dried.

## c) Storage

- Store the product in the supplied carrycase.
- After using, ensure all water has been emptied and dry the outside of the unit.
- Do not submerge in water

# Technical Specification



| Part Number        |  | AQUASCAN                 |                  |
|--------------------|--|--------------------------|------------------|
| <b>Warranty</b>    |  | 1 year                   |                  |
| <b>Dimensions</b>  | <b>AquaScan with isolation valve (product only)</b>      | Height (mm)              | 180              |
|                    |  | Width (mm)               | 125              |
|                    |  | Depth (mm)               | 80               |
|                    |  | Weight (kg)              | 1                |
|                    | <b>AquaScan including carry case and contents</b>        | Height (mm)              | 370              |
|                    |  | Width (mm)               | 300              |
|                    |  | Depth (mm)               | 170              |
|                    |  | Weight (kg)              | 4.2              |
| <b>Product</b>     | <b>Inlet connection</b>                                  | ½" female thread (brass) |                  |
|                    | <b>Outlet connection</b>                                 | ¾" male thread (brass)   |                  |
|                    | <b>Enclosure protection</b>                              | IPX5                     |                  |
|                    | <b>Active display size</b>                               | W45mm x H55mm            |                  |
|                    | <b>Waterway material</b>                                 | Brass waterway           |                  |
|                    | <b>Media</b>   | Clean, potable water     |                  |
| <b>Electrical</b>  | <b>Nominal voltage type</b>                              | 3.7V                     |                  |
|                    | <b>Battery type</b>                                      | Lithium Polymer          |                  |
|                    | <b>Battery life (on full charge)</b>                     | approx. 12 hours         |                  |
|                    | <b>Battery charge time (based on 0.5A supply)</b>        | up to 7 hours            |                  |
|                    | <b>Battery charge voltage</b>                            | 5V                       |                  |
|                    | <b>Battery rated capacity</b>                            | 2400mAh                  |                  |
|                    | <b>Charging port</b>                                     | USB-C                    |                  |
|                    | <b>Automatic shut off time</b>                           | 20 mins                  |                  |
| <b>Measurement</b> | <b>Pressure</b>  | Units                    | Bar              |
|                    |  | Measuring range          | 0-10             |
|                    |  | Accuracy                 | 1.5% full scale  |
|                    | <b>Flow</b>  | Units                    | L/min            |
|                    |  | Measuring range          | 0-30             |
|                    |  | Accuracy                 | 5% of reading    |
|                    | <b>Temperature</b>                                       | Units                    | °C               |
|                    |  | Measuring range          | 0-85             |
|                    |  | Accuracy                 | 1.25% full scale |
|                    | <b>Total Dissolved Solids (TDS) (hardness indicator)</b> | Units                    | PPM              |
|                    |  | Measuring range          | 0-1000           |
|                    |  | Accuracy                 | 10% of reading   |

The company operates a policy of continuous development and reserves the right to change any of the specifications of its products without prior notice. All information data and illustrations given in this leaflet may be subject to variation.

# Troubleshooting

Please see table below for troubleshooting guidance should you experience an issue with AquaScan. If this does not provide a solution, then please contact our Customer Service Team for support.

| Identified problem                | Probable cause                               | Recommended solution  |
|-----------------------------------|--|---|
| <b>AquaScan will not power on</b> | AquaScan is not switched on                  | Turn on AquaScan by holding down the power button for 2 seconds.  |
|                                   | AquaScan not fully charged                   | Charge AquaScan for 7 hours using the USB cable provided.   |
|                                   | Power button not fully pressed for 2 seconds | Press and hold the power button for 2 seconds, a faint click should be heard.<br><br>Clean the control buttons with a damp cloth and try pressing the power until back-light is activated and the display screen visible. |

| Identified problem          | Probable cause         | Recommended solution  |
|-----------------------------|------------------------|---|
| <b>Battery not charging</b> | Fault with power cable | <p>Check both ends of the USB charging cable for any visible damage - replace if necessary.</p> <p>Fully insert USB-C charger into the charging port and into a power supply. With the power on, the battery level indicator in the top right of the AquaScan display will animate to indicate charging:</p>  <p>AquaScan power off and charging:</p>  <p>If AquaScan does not charge when using the original USB charger, use alternative power source to retry charging the unit.</p> |
|                             | Cannot plug in charger | Check charging port on handset for any blockage/ debris.  |

| Identified problem  | Probable cause            | Recommended solution  |
|---|---------------------------|---|
| <b>Battery not charging continued</b>                                       | AquaScan has overheated   | If AquaScan feels hot or warm allow it to cool, moving it into a cooler area if it has been in the heat to lower the temperature, before recharging the unit. Never leave AquaScan in direct sunlight.  |
| <b>Screen is turning on, but readings are not displayed during testing.</b> | Flow rate not displayed   | Ensure that the outlet supplying AquaScan is fully open and that the isolation valve on AquaScan is open to allow water to pass through. Check for any restrictions into or out of AquaScan.  |
|   | Pressure not displayed    | Ensure the isolation valve is fully closed and no other outlets in the property are open. If the pressure in the property is generally low, it may be too low to register during a dynamic pressure test.   |
|   | Temperature not displayed | Close the isolation valve then reopen, allowing any air to clear from AquaScan.<br><br>If testing a tap, fully open the outlet and run the hot then cold water through for 30 seconds. When changing from cold to hot, allow 30 – 60 seconds settle time for AquaScan to accurately read water temperature. |
|   | QR code display is shown  | Press display button to change display to either the animated or simple display to view readings.   |

| Identified problem   | Probable cause                                    | Recommended solution   |
|--|---|--|
| <b>Screen is turning on, but readings are not displayed during testing continued</b>   | TDS (hardness indicator) not displayed            | Open and close the isolation valve a few times to ensure that no air is trapped in AquaScan. Ensure the isolation valve is fully closed and that the reading is taken before any water softener. Allow 30 – 60 seconds settling time before taking a reading.  |
| <b>Reading is not accurate</b><br>(Expected measurement ranges and tolerances are specified in the Technical Specification in the user guide. The readings may vary during the day with fluctuations in the system. Taking readings at both 'peak' and 'off- peak' times will give a more accurate reading). | Flow reading is fluctuating when in use           | Allow 30 – 60 seconds for the flow to stabilise when measuring the flow rate. Ensure other outlets are not unintentionally opened when taking the reading. Take three separate readings for a more accurate measurement.   |
|  | Flow reading is lower or higher than expected     | The 'peak' reading against the 'live' reading will help you see the increase/ decrease in the measurement during testing. Check that there are no leaks on the connection between AquaScan and the outlet/system/pipework.   |
|  | Pressure reading is higher or lower than expected | Ensure all outlets are closed and that there are no leaks in the pipework before the testing point. If the static pressure falls and the isolation valve is closed it may indicate a drop in pressure from the pipework or an outlet before AquaScan. The peak measurement will show the initial reading. Check that there are no leaks on the connection between AquaScan and the outlet/system/pipework. Pressure will naturally fluctuate, particularly in mains-fed systems. |



| Identified problem                       | Probable cause  | Recommended solution  |
|--|---|---|
| <b>Reading is not accurate continued</b> | Temperature reading is higher or lower than expected      | Heat exposure or extreme changes in temperature in the environment that AquaScan is being used in may affect the readings taken during the test. Allow water to flow through the unit for a minimum of 30 seconds to allow water and unit temperature to stabilise.               |
|  | TDS (hardness indicator) is higher or lower than expected | Open and close the isolation valve a few times to ensure that no air is trapped in AquaScan. Ensure the isolation valve is closed then wait 30 – 60 seconds before taking the reading.<br><br>Rinse any filtered water through the unit and retake measurement.                   |
| <b>Unit turns off during testing</b>     | Auto shut off   | After 20 minutes AquaScan will power off to preserve battery life. Press and hold the power button for two seconds on the unit to power on AquaScan and continue measuring.<br><br>Ensure the button is not accidentally pressed during testing and that the button is not stuck. |
|  | Battery requires charging                                 | Recharge the battery for 7 hours, checking that the battery level indicator increases and retry testing.  |
|  | AquaScan is excessively hot when in use                   | Allow AquaScan to cool down before using and keep out of direct sunlight. Store in the carry case provided.   |

## Warranty

### **AquaScan benefits from a one-year warranty.**

**PLEASE NOTE: Product misuse, tampering, alterations, accidental damage and non-conformity with the instruction manual WILL invalidate the product warranty.**

Salamander Pumps operates a policy of continuous development and reserves the right to change any of the specifications of its products without prior notice. All information data and illustrations given in this leaflet may be subject to variation.

To get the most from your Salamander Pumps product, please follow the user guide provided, ensure it is stored in the protective case supplied, and only use the power supply provided for charging.

### **Further Technical Assistance**

For more details and further technical assistance please consult our Customer Service Team:

Telephone: 0191 516 2002

E-mail: Tech@salamanderpumps.co.uk

# Terms and Conditions

## **AquaScan Terms and Conditions (UK, Northern Ireland & ROI Republic of Ireland)**

### **1. The Scope of the Warranty**

SALAMANDER PUMPED SHOWER SYSTEMS LTD (“the Company”) Warrants subject to the terms and conditions below for the Warranty period(s) specified in paragraph 3 that the Company shall: Repair or replace free of charge the product(s) specified on the Online Warranty Registration or Telephone Warranty Registration any component part thereof (together referred as “the equipment”) which shall in the opinion of the Company have proved defective by reason only of the Company’s materials or workmanship. The Company shall be under no obligation whatsoever under this Warranty to repair or replace equipment which has been misused, tampered with, or modified/ altered in any way without the consent in writing from the Company; or if any component or accessory has been replaced by a type not specified by the Company; operated or used other than as described in the instruction manual; or if any servicing or repair of the equipment shall have been carried out by anyone other than an authorised Company dealer appointed by the Company (“dealer”).

The Company’s liability under this Warranty is limited to the said repairs or replacement and shall under no circumstances extend to any financial loss or damage including consequential losses alleged to have been suffered by the claimant.

Salamander Pumps offer a product only warranty, this does not cover any labour or accidental damage caused due to incorrect use of the product.

Subject as provided in this warranty and except where the equipment is sold to a person dealing as a consumer all warranties, conditions or other terms implied by law are excluded to the fullest extent permitted by law.

Nothing in this warranty shall exclude liability for death or personal injury caused by the Company’s negligence.

### **2. Terms and conditions**

This Warranty shall only be enforceable by you if the following terms and conditions have been complied with:

- a. That the product has been used in accordance with the user guide.
- b. You must evidence the date of purchase by retaining the original invoice from the dealer. Without such evidence the Company reserves the right to reject any such claims under the terms of this Warranty.
- c. Within 15 days of purchase of the equipment the Warranty registration is accurately completed online or over the telephone.
- d. Within 30 days of discovery of a defect giving rise to liability under paragraph 1 above you give notice thereof in writing to the Company.
- e. Provided the product has not been altered, tampered with, modified, or transformed in any way, or incurred accidental damage or been used outside of the guidance provided in this document (the user guide).

### **3. The Warranty periods**

The Warranty period referred to in paragraph 1 is detailed below:

- a. This AquaScan product, manufactured by the company, comes with a warranty 1 year from date of purchase provided the warranty registration is completed online or over the phone within 15 days of purchase.
- b. The warranty period in respect of any product repaired or replaced under the warranty shall be part of the above period(s) which remain unexpired.
- c. In the event of a claim for repairs or replacement being made under the terms of this Warranty, a return of the product in full or in part will be required. In circumstances where in the opinion of the Company the defect has not been caused by the Company’s materials or workmanship then the Company reserves the right to invalidate the warranty and return the product to the sender. Please also see above instances which will invalidate the warranty.
- d. This Warranty is given in addition to and does not affect your statutory rights as a consumer.

- f. This Warranty is valid and enforceable for equipment purchased and used exclusively in the UK and The Republic of Ireland only.
- g. No authority has been given to any person, firm, or company to vary the terms of this Warranty.
- h. Warranty does cover accessories supplied.



Get in touch, we're here to help  
call us on 0191 516 2002

Unit 2c Colima Avenue  
Enterprise Park West  
Sunderland, SR5 3XE



## Register your product

Online: [www.salamanderpumps.co.uk](http://www.salamanderpumps.co.uk)

By phone: 0191 516 2002



**MADE IN  
BRITAIN** 

**Pump**  **wise**