

STUART

Installation, Operation & Maintenance Instructions

Please leave this instruction booklet with the home owner as it contains important warranty, maintenance and safety information



Read this manual carefully before commencing installation.

This manual covers the following products:

ST 15/60 (130) Circulator 230 V

Pt. No. 47073

ST 15/60 B (130) Circulator 230 V

Pt. No. 47074

ST 25/80 (180) Circulator 230 V

Pt. No. 47075

PRODUCT DESCRIPTION

The ST Circulator is designed for the circulation of a liquid within central heating systems and offers constant pressure or ability to continuously measure the system pressure and optimise its performance within the selected pressure setting.

APPLICATION

The ST 15/60 B is designed to constantly circulate hot water within an open system. The ST 15/60 & ST 25/80 are designed to constantly circulate hot water within a closed loop system.

STORAGE

If this product is not to be installed immediately on receipt, ensure that it is stored in a dry, frost and vibration free location in its original packaging.

CONTENTS

	Page
Checklist4
Pumped Medium5
Installation6
Electrical Installation7
Pump Settings8
Technical Specification8
Trouble Shooting9
Curves10
Warranty11

WARNINGS:



- This appliance can be used by children aged from 8 years and above and persons with reduced physical, sensory or mental capabilities or lack of experience and knowledge if they have been given supervision or instruction concerning use of the appliance in a safe way and understand the hazards involved.
- Children shall not play with the appliance.
- Cleaning and user maintenance shall not be made by children without supervision.
- The motor casing can become very hot under normal operating conditions. Care must be taken to ensure it cannot be touched during operation.



- The electrical installation must be carried out in accordance with the current national electrical regulations.
- The electrical installation must be installed by a qualified person.
- Do not run the pump dry.
- System pressure must not exceed 10 bar.
- Before starting work on the electrical supply ensure power supply is isolated.
- DO NOT allow the supply cord to contact hot surfaces, including the motor shell, pump body or pipework. The cord should be safely routed and secured by cable clips.
- This appliance must be earthed via the supply cord, which must be correctly connected to the earth point located in the terminal box.

Please read installation details carefully as they are intended to ensure this product provides long, trouble free service. Failure to install the unit in accordance with the installation instructions will lead to invalidation of the warranty.

CHECKLIST

IMPORTANT: With the pump removed from its packaging check for any damage prior to installation. If any damage is found contact Stuart Turner Ltd within 24 hours of receipt.



Fig. 1

Note: This image is for reference only.

Item	Description	Qty
(A)	Pump	1
(B)	Washers	2

Your product may vary slightly from the picture above.

1 PUMPED MEDIUM

- 1.11 For normal operation of the pump it is necessary to use clean water, or a mix of clean water and antifreeze. This should be suitable for central heating systems and in accordance with the current standards such as EN 1228. The liquid must not contain aggressive or explosive supplements, mineral oils and solid or long fibres.
- 1.12 The pump must not be used for transfer of flammable and explosive liquids or in an explosive atmosphere.
- 1.13 Temperature of medium should not be lower than ambient temperature to avoid condensation forming on the pump.
- 1.14 Operation outside recommended conditions may shorten pump life and will void the warranty.

2 INSTALLATION

2.11 The pump must be installed with the motor shaft in the horizontal plain (Fig. 1) allowing the flow through the inlet/outlet to be either vertical or horizontal (Fig. 2).

Note: The arrow on the pump case indicates the direction of flow.

Pump terminal box

If the pump is installed where access to the terminal box is limited it can be repositioned in the following manor (Fig. 3).

- Isolate pump from the water services using 1½ " pump valves.
 - Isolate power.
 - With pump key remove four retaining screws.
 - Pull motor/terminal box assembly away from pump body.
 - Rotate motor terminal assembly box to desired position.
 - Re-install using instructions above in reverse order ensuring sealing 'O'-ring correctly located.
- 2.12 Before starting pump, open pump valves and bleed system through. Pressurise system to suit.

Any trapped air in the pump may cause excessive noise when started. If it does not clear after 1-2 minutes of running, stop and start pump.



- Note system pressure must not exceed 10 bar.
- Do not run the pump dry.
- The pump casing will get hot as the liquid temperature rises, and must not be touched.

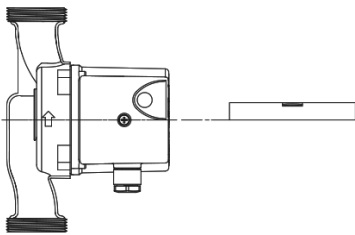

Fig. 1

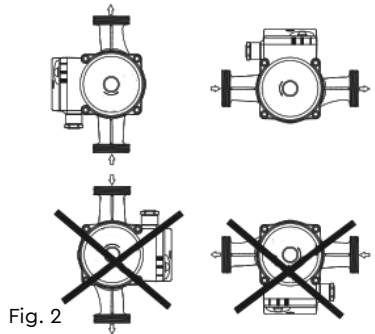

Fig. 2

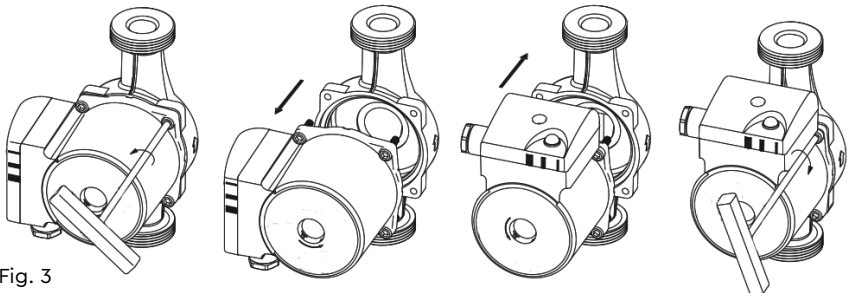

Fig. 3

3 ELECTRICAL INSTALLATION / EARTHING



- 3.11 **Regulations:** The electrical installation must be carried out in accordance with the current local regulations by a qualified person.
- 3.12 **Safety:** In the interests of electrical safety a 30 mA residual current device (**R.C.D. not supplied**) should be installed in the supply circuit. This may be part of a consumer unit or a separate unit.
- 3.13 Before starting work on the electrical supply ensure power supply is isolated.

- 3.14 **Earthing:** This appliance must be earthed via the supply cord, which must be correctly connected to the earth point located in the terminal box.
- 3.15 **Cable fitting:** The pump must be fitted with 3 core 1 mm² HO5 RR-F or equivalent cable and permanently connected to the fixed wiring of the mains supply using the factory fitted supply cord, via a dedicated double pole switched fused spur off the ring main.
- 3.16 **DO NOT** allow the supply cord to contact hot surfaces, including the motor shell, pump body or pipework. The cord should be safely routed and secured by cable clips, alternatively the cord must be protected by an insulating sleeving with appropriate temperature rating.
- 3.17 **Wiring of connection unit:**



WARNING: This appliance must be earthed.

The wires in the mains lead (supply cord) are coloured in accordance with the following code:

- Green and Yellow: Earth (PE)
- Blue: Neutral (N)
- Brown: Live (L)

As the colours of the wires in the mains lead of this appliance may not correspond with the coloured markings identifying the terminals in your connection unit proceed as follows:

- The wire which is coloured green and yellow must be connected to the terminal in the connection unit which is marked with the letters PE or by the earth symbol: ⊕ or coloured green or green and yellow.
- The wire which is coloured blue must be connected to the terminal which is marked with the letter N or coloured black.
- The wire which is coloured brown must be connected to the terminal which is marked with the letter L or coloured red.

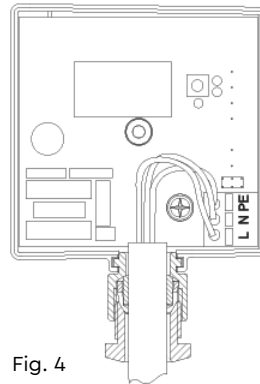

L = Live
N = Neutral
PE = Earth

Fig. 4

- 3.18 **Fuse:** All models should use a 5 Amp fuse.

Cont ...

4 PUMP SETTINGS

- 4.11 This pump has three different preset curves with proportional pressure, or three curves with constant power available by pressing the button on the terminal box cover consecutively.
- 4.12 The button illuminates to indicate the performance selected.
- Blue – lowest power
 - Green – medium power
 - Yellow – highest power
- 4.13 To select the desired pressure with proportional pressure (optimising pump performance to the system requirements) press the button down >5 seconds, the light in the button will now pulse faster – slower depending on speed of the pump.
- Press the button again in short succession until return the pump to constant power mode, the light will then shine constantly while in this setting.

5 TECHNICAL SPECIFICATION

Pump Model		ST 15/60 47073	ST 15/60B 47074	ST 25/80 47075
General	Warranty	5 year	3 year	5 year
	WRAS approval	-	Compliant materials	-
Features	Pump type	Centrifugal		
	EFF	38 %		36 %
	EI	0.18	0.18	0.20
	Noise	43 dB(A)	43 dB(A)	43 dB(A)
Materials	Pump body	Cast iron	Bronze	Cast iron
	Impeller	Noryl	Noryl	Noryl
	Bearings	Ceramic		
Performance	Maximum head (closed valve)	5.8 metres	5.8 metres	8 metres
	Maximum flow	3.3 m ³ /h	3.3 m ³ /h	4.5 m ³ /h
	Maximum working pressure	10 bar		
	Maximum ambient air temperature	40 °C		
	Min / Max water temperature	-10 / +110 °C		
Connections	Pump connections	1 ½ "		
Motor	Type	Canned Rotor		
	Duty rating	Continuous (S1)		
Electrical	Power supply / phase / frequency	230 / 1 / 50		
	Current (full load)	0.32 Amps		0.5 Amps
	Max. power consumption	36 Watts		57 Watts
	Fuse rating	5 Amp		
	Insulation class	F		
	Enclosure protection	IP44		
Physical	Length	132 mm	132 mm	130 mm
	Width	125 mm	125 mm	125 mm
	Height	130 mm	130 mm	180 mm
	Weight	2.2 Kg	2.2 Kg	2.4 Kg

Stuart Turner reserve the right to amend the specification in line with its policy of continuous development of its products.

6 TROUBLE SHOOTING GUIDE

Symptoms	Probable Cause	Recommended Action
Indicator light is off, pump is not pumping any water.	No power.	Check electric installation and fuses.
Indicator light is permanently on.	The unregulated performance may have been chosen	Choose regulated performance.
Indicator light changes colour.	Pump is blocked.	Clean pump.
Sounds and noises in the system.	Pump or system is not appropriately vented.	Vent the system.
Too low water flow rate.	The selected setting is too low.	Select a higher performance.

- 6.11 **Environment Protection:** Your appliance contains valuable materials which can be recovered or recycled.
At the end of the products' useful life, please leave it at an appropriate local civic waste collection point.

7 CURVES

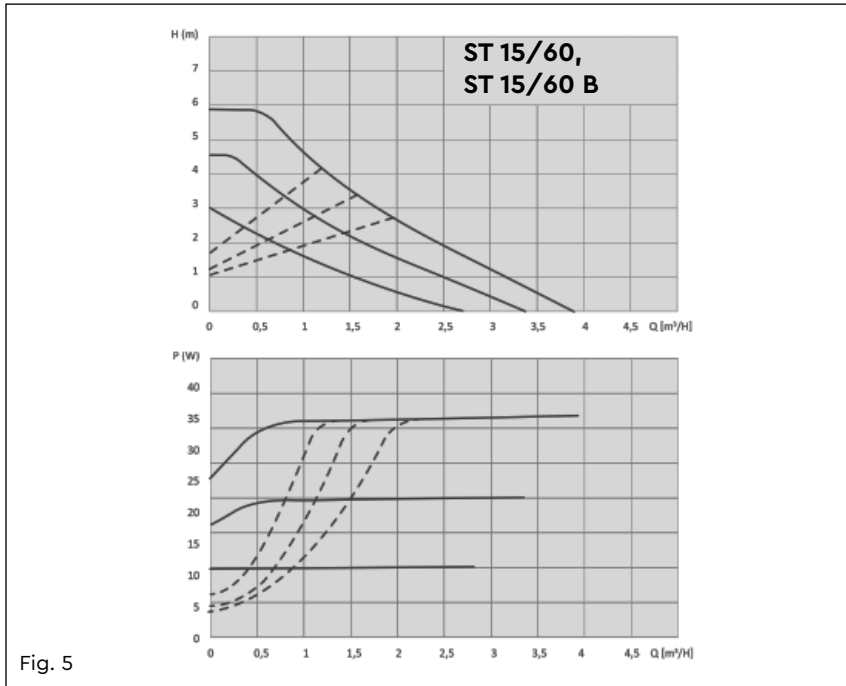

Fig. 5

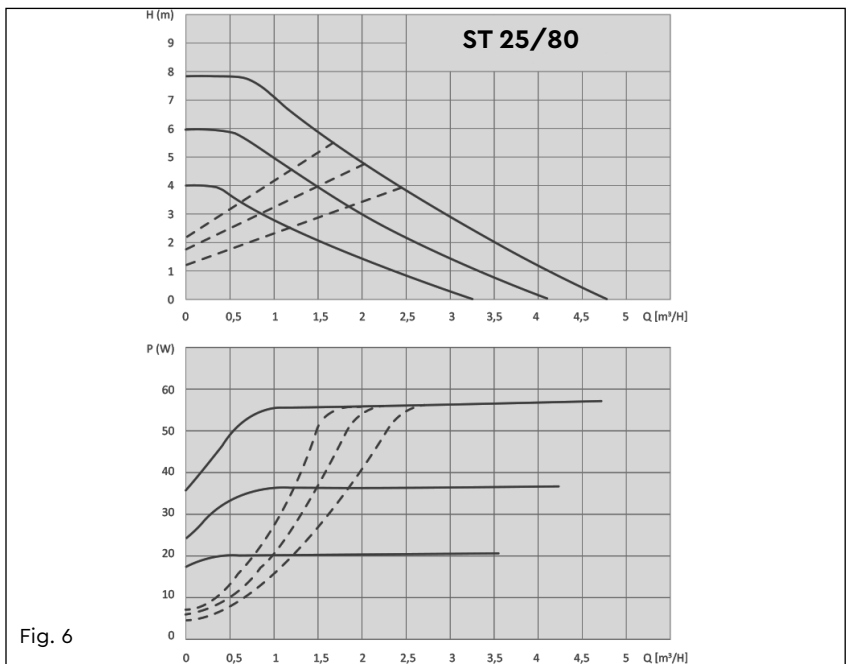

Fig. 6

Cont ...

10 THE WARRANTY

Congratulations on purchasing a Stuart Turner pump.

ST 15/60 (130) Circulator 230 V	5 year warranty
ST 25/80 (180) Circulator 230V	5 year warranty
ST 15/60 B (130) Circulator 230V	3 year warranty

We are confident this pump will provide many years of trouble free service as all our products are manufactured to the very highest standard.

All Circulators are warrantied to be free from defects in materials or workmanship for the period of the warranty.

Within the warranty period we will repair, free of charge, any defects in the pump resulting from faults in material or workmanship, repairing or exchanging the whole unit as we may reasonably decide.

Not covered by this warranty: Damage arising from incorrect installation, improper use, unauthorised repair, normal wear and tear and defects which have a negligible effect on the value or operation of the pump.

Reasonable evidence must be supplied that the product has been purchased within the warranty term prior to the date of claim (such as proof of purchase or the pump serial number).

This warranty is in addition to your statutory rights as a consumer. If you are in any doubt as to these rights, please contact your local Trading Standards Department.

Ensure the product you have purchased is correct for your region to avoid invalidating the warranty.

In the event of a claim please telephone '**TechAssist**' or return the pump and flexible hoses with the accessories removed e.g pipes etc. If you have any doubt about removing a pump, please consult a professional.

+44 (0) 800 31 969 80

Proof of purchase should accompany the returned unit to avoid delay in investigation and dealing with your claim.

You should obtain appropriate insurance cover for any loss or damage which is not covered by Stuart Turner Ltd in this provision.

Please record here for your records.

TYPE NO.	SERIAL NO.	DATE PURCHASED
----------	------------	----------------



DECLARATION OF CONFORMITY

**Supply of Machinery Regulations - 2008**

EN ISO 12100:2010, EN 809:1998+A1:2009/AC:2010

Electrical Equipment Regulations - 2016

EN 60335-1:2012/A2:2019, EN 60335-2-41:2003/A2:2010, EN 60335-2-51:2003+A2:2012

EMC Regulations - 2016

EN 55014-1, EN 55014-2, EN 61000-3-2, EN 61000-3-3, EN 61000-4-2, EN 61000-4-3, EN 61000-4-4, EN 61000-4-5, EN 61000-4-6, EN 61000-4-11

Ecodesign for Energy Related Products & Energy Information (Amendment) (EU Exit) - 2019

EN 16297-1:2012

EMF Regulations - 2016

EN 62233:2008

RoHS Regulations - 2012

EN IEC 63000:2018

Machinery Directive - 2006/42/EC

EN ISO 12100:2010, EN 809:1998+A1:2009/AC:2010

Low Voltage Directive - 2014/35/EC

EN 60335-1:2012/A2:2019, EN 60335-2-41:2003/A2:2010, EN 60335-2-51:2003+A2:2012

EMC Directive - 2014/30/EU

EN 55014-1, EN 55014-2, EN 61000-3-2, EN 61000-3-3, EN 61000-4-2, EN 61000-4-3, EN 61000-4-4, EN 61000-4-5, EN 61000-4-6, EN 61000-4-11

ECO Design Directive - 2009/125/EC

EN 16297-1:2012

Circulators: Commission Regulation No 641/2009 - EN 16297-2:2012

EMF Directive - 1999/519/EC

EN 62233:2008

RoHS Directive - 2011/65/EU

EN IEC 63000:2018

WEEE Directive - 2012/19/EU

IT IS HEREBY CERTIFIED THAT THE STUART ELECTRIC MOTOR DRIVEN PUMP AS SERIAL NUMBER BELOW, COMPLIES WITH THE ESSENTIAL REQUIREMENTS OF THE ABOVE STATUTORY REGULATIONS & E.U. DIRECTIVES.



STUART TURNER LIMITED
HENLEY-ON-THAMES, OXFORDSHIRE
RG9 2AD, ENGLAND.
RESPONSIBLE PERSON AND MANUFACTURER

EU AUTHORISED REPRESENTATIVE
ARC (AUTHORISED REP COMPLIANCE)
GND FLOOR, 71 LOWER BAGGOT
STREET, DUBLIN,
D02 P593, IRELAND.

Signed.....

Stuart Turner are an approved company to BS EN ISO 9001:2015



Stuart Turner Ltd, Henley-on-Thames, Oxfordshire RG9 2AD ENGLAND

Tel: +44 (0) 1491 572655 Fax: +44 (0) 1491 573704

info@stuart-turner.co.uk | www.stuart-turner.co.uk